

10 reasons to select Solid Edge with Synchronous Technology

www.siemens.com/solidedge

white paper

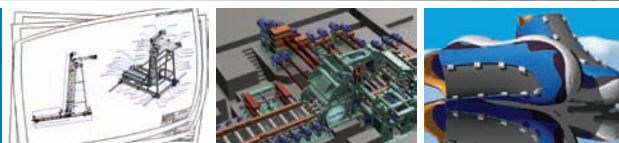

- ▶ Solid Edge® software delivers the best value and lowest total cost of ownership found in the mainstream CAD market today. This paper presents 10 reasons why selecting Solid Edge is a wise business decision.

PLM Software

Answers for industry.

SIEMENS

Table of contents

Introduction	1
1. Unique paradigm for fast/ flexible modeling	2
2. Superior transition from 2D to 3D	4
3. Complete product modeling toolset	5
4. Best sheet metal modeling in its class	7
5. Optimal performance and management of massive assemblies	8
6. Production-proven 2D drafting	9
7. Scalable design and failure analysis	10
8. Collaboration throughout the supply chain	10
9. Scalable design and design management solutions	11
10. Velocity Series	12

► 10 reasons to select Solid Edge with Synchronous Technology

Introduction

Most of us know the benefits of a 3D CAD strategy – reduced rework, shortened time-to-market, improved product features and more. But smart companies succeed because they make smart decisions. They know not all CAD systems are created equal.

If you want your company to be a market leader, you need to out-innovate your competition. Today's most forward-thinking companies are continuously improving their products and processes – and organizing their value chain so that innovation can flourish. Siemens PLM Software's Solid Edge is the most cost effective, complete and open solution for 2D and 3D design and collaboration, helping you meet these key business requirements:

- Accelerate top-line growth
- Contain costs
- Reduce time-to-market
- Optimize resources
- Leverage globalization

Solid Edge is what it says – technologically superior 3D CAD, smart service and support that's always there, and a product unique architecture that's designed to take your design into the future.

This document explores 10 solid reasons why more and more smart companies are selecting Solid Edge to meet the 5 key business requirements listed above. Select Solid Edge – your best option for gaining a competitive edge in product design.



Siemens PLM Software

Solid Edge[®]

with Synchronous Technology

VELOCITY SERIES

Siemens and the Siemens logo are registered trademarks of Siemens AG. ©2008 Siemens Product Lifecycle Management Software Inc. All rights reserved. Solid Edge is a registered trademark and Velocity Series is trademark of Siemens Product Lifecycle Management Software Inc. This software and related documentation are proprietary to Siemens Product Lifecycle Management Software Inc.

SIEMENS

► 10 reasons to select Solid Edge with Synchronous Technology

I. Unique paradigm for fast/flexible modeling – Design faster than your competition with your current design team

The most important question today's manufacturing companies continue to try to answer is "How do I design faster than my competition with my current design team." All face stiff competition on the road to success, and in a changing market place, traditional systems and process just don't allow you to react fast enough. Any savings from outsourcing are often washed away when changes happen.

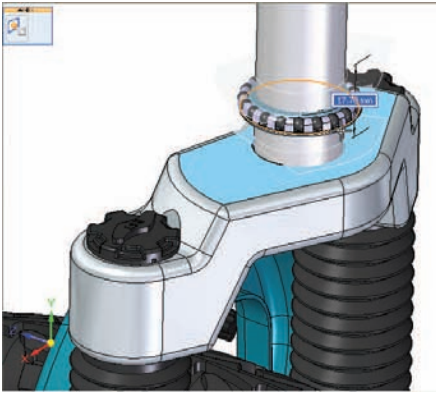

To maintain a competitive edge you need to out-innovate your competition and

deliver products faster, to command market share and maximize your product's potential. Current 3D design technology has been around for some time. Even with the fastest computers and trained users, current technology is being stretched, stifling your ability to meet even greater demands on design throughput.

Solid Edge with Synchronous Technology is the most complete feature-based 2D/3D CAD system available on the market today. It combines the speed and flexibility of direct modeling with precise control of dimension-driven design to provide the fastest, most flexible design experience possible. Ready to revolutionize the way you think about 3D design, Solid Edge with Synchronous Technology allows you to:

- Innovate faster with a new interactive design environment
- Iterate designs with unbounded speed and flexibility
- Edit outsourced CAD data faster than the vendor who supplied it
- Harness the power of 3D with the simplicity of 2D

Capture your ideas as fast as you can think them

Today's design tools force users to spend precious engineering time preplanning designs for future use and because current CAD technology forces edits to follow the create steps, you can't iterate different design scenarios without starting from scratch. Solid Edge with Synchronous Technology allows you to create designs as fast as you can think them and delivers a 100x faster design experience using:

- Integrated 2D and 3D sketching allowing you to draw in 2D, and immediately creating 3D geometry without separate feature steps
- Region-based design allowing you to identify areas within a sketch or model to generate 3D geometry by pulling and pushing into position

- Feature collections features, which are now peers so they are no longer dependent on each other for your geometry to solve; they can be used for selection or sorted as you wish
- 3D parametric design allowing you to persist 2D dimensions to 3D geometry, use tables and formulas to drive model size and use directional control on dimensions
- Steering wheel and 3D handles that provide grab-and-go editing capabilities
- Office 2007 Style user interface and a redesigned EdgeBar that further enhance productivity

If you are using traditional 3D CAD, saving over \$76,000 per year during your development phase is not an unrealistic figure, even with uncomplicated designs. Traditional CAD forces you to make changes per the creation steps, so any last minute ideas generally require a good bit of rework. Expect to strategize the change, wait for the results, then fix any problems with downstream failures. By eliminating the need to preplan designs, you will realize up to 100 times faster design experience. A faster design experience directly translates into faster time-to-market so you can capture more revenue quicker. Shorter design cycles will also give you more time to develop new projects, again further helping your company's revenue stream.

Change your models as fast as you can change your mind

Today's traditional CAD tools force change in the same manner as create, so users have to spend precious engineering time first, just understanding that process. Because those systems use a history approach, models have to be constrained a specific way – and usually not the way you need – so expect to spend time fixing any broken features downstream from the change. The most desirable and natural

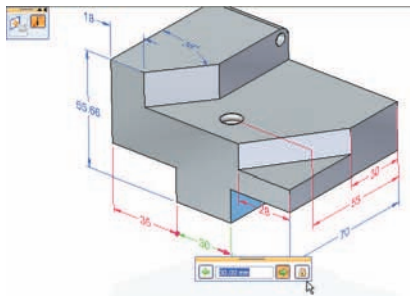

way to edit is to change the geometry, not some underlying constraint system, an unrelated feature or a parent sketch. Solid Edge with Synchronous Technology uses a combination of breakthrough technology to allow design modifications in seconds instead of hours using:

- Live Rules which automatically find and maintain geometric conditions during a drag or even a dimensional edit, so intuitive as well as novice users will 'get it right'
- 3D driving dimensions, added directly to your models independently from creation order to provide directional edit control with exact results

► 10 reasons to select Solid Edge with Synchronous Technology

- Procedural features which provide direct access to key parameters for hole patterns, thinwall and rounds, maintaining feature-based design without feature-to-feature dependencies
- Table- and formula-driven design capabilities providing highly automated, parametric design functions
- Synchronous solve allowing bidirectional direct geometry editing. Features can be edited regardless of the order they were created, eliminating any parent/child dependencies between features, either in a single part or across multiple components in an assembly

Because edits in a history-based system require both model regeneration and feature cleanup when things fail, changes become unpredictable and time consuming. These problems are compounded as more and more features are added to your model. With synchronous technology Solid Edge suffers no downsides of parametric modeling and delivers performance gains that scale as your model becomes more complex. Our tests show that performance doesn't scale with model size; with synchronous technology edits are nearly instant. In the chart below notice how the times for synchronous technology are flat across the board. Using Solid Edge with Synchronous Technology, you can edit the first operation as fast and easily as the last operation.

Model edit performance

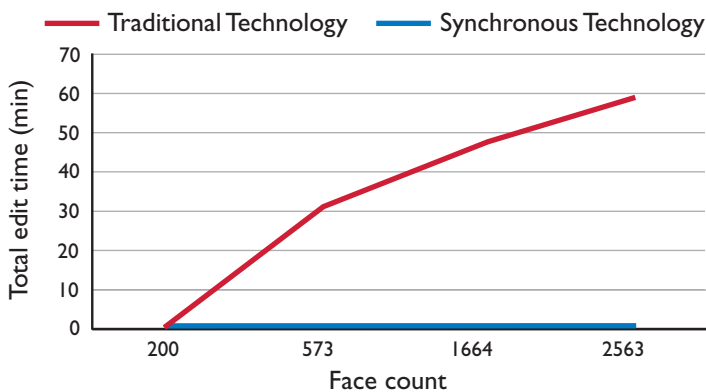

Thrive in a multi-CAD world

If you want to design faster than your competition you have to be able to thrive in a multi-CAD world. So why can't you do that today? Most CAD systems can interchange data through neutral data exchange formats. The most common ones are JT, X_T, STEP and IGES. Simplifying the translation, some systems read CAD data directly, skipping the Save As step. However, that's where the simplicity ends.

In order to manipulate geometry, you need to be able to select geometry quickly. Since the import process loses features, you need a fast, easy way to select geometry so an automated selection method is a must.

A powerful Selection Manager in Solid Edge provides an automatic selection based on a geometric function. This powerful tool can find groups of faces that "look" like a

rib, boss or cutout. It can also find elements that are parallel, perpendicular and even cylindrical faces of equal diameter. The Selection Manager works the same

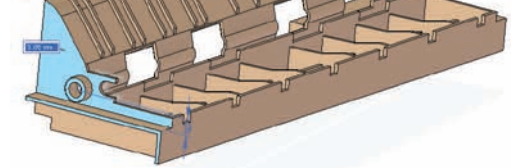

for native or imported data so users aren't burdened with learning commands specific to handling just-imported data. The geometry found can be saved into a user-defined feature for future edits or added to a feature library for re-use later.

Figures from our studies show how companies using Solid Edge with Synchronous Technology can save over \$38,000 per year by avoiding downtime and waiting on updates from their suppliers.

Solid Edge with Synchronous Technology business advantage #1:

- Design faster than your competition with your current design team
- Capture your ideas as fast as you can think them
 - Eliminate model regeneration and perform ECOs in seconds
 - No need to preplan your designs
 - Get up to a 100x faster design experience
 - Faster time-to-market – means more revenue
 - More products – with no more costs
 - More iteration means higher quality designs
- Change your models as fast as you can change your mind
 - Make design changes at will, without having to preplan your design
 - Eliminate model regeneration during design time
 - Improve customer response time for more repeat business
 - Increase design re-use and reduce costs for redevelopment
 - Fewer modification steps lessens chance for errors
- Thrive in a multi-CAD world
 - Edit imported data as native Solid Edge
 - Make changes up to 100x faster than the supplier – even SolidWorks or Autodesk Inventor
 - Less downtime waiting for supplier turnarounds
 - In-house changes eliminates supplier change fees
 - Eliminate quality issues with 2D markups using edited 3D models

For more details on Solid Edge with Synchronous Technology, ask your salesperson for a copy of the Solid Edge with Synchronous Technology fact sheet, or download directly from www.solidedge.com.

▶ 10 reasons to select Solid Edge with Synchronous Technology

2. Superior transition from 2D to 3D

Many companies transitioning from AutoCAD and other 2D products find that learning and maintaining multiple design systems hinders their smooth transition to the productive world of 3D. The traditional answer from 3D vendors is to give up on your 2D data and jump head first into 3D. Solid Edge is the only practical design system allowing you to create from scratch 2D data, and edit or maintain your legacy 2D data from multiple systems while you move to 3D – at your own pace and using a single product. By following Siemens' proven 4-step "evolve to 3D" process, users upgrading from 2D AutoCAD to Solid Edge enjoy a smooth workflow and a consistent, familiar look and feel to their drawings – shortening the learning curve while ensuring consistency and data integrity.

- Step 1** ▶ Continue today's 2D productivity while learning tomorrow's 3D design tools
- Step 2** ▶ Turn 2D geometry into real 3D parts
- Step 3** ▶ Apply the power of a hybrid 2D/3D design workflow
- Step 4** ▶ Realize the benefits of PLM with Solid Edge and Velocity Series™ software

Harness the power of 3D with the simplicity of 2D

Making CAD accessible to all areas of your organization has always been a challenge. New hires proficient with 2D drawing skills need to edit your engineers' 3D models; engineers or analysts need to test strengthening concepts on 3D models; and the machining department may need to adjust a blend radius to reduce manufacturing costs – not to mention the engineering managers who want to experiment with what-if scenarios. Solid Edge with Synchronous Technology makes experts out of novices and casual users.

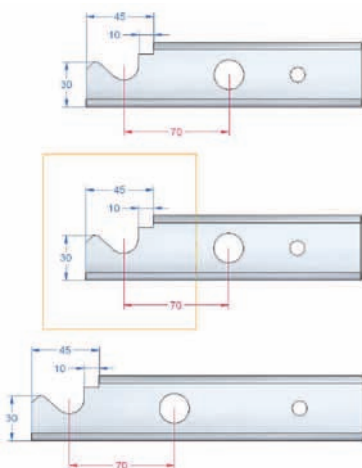

To speed the process, sketching and modeling are contained in a single design environment, so after drawing use grab-and-go handles to turn regions into a 3D model. Draw in 3D space or directly on the part; with sketch inferencing, intent is implied based on cursor position. Sketches become consumed and are no longer needed because edits are ultimately made directly to the 3D model.

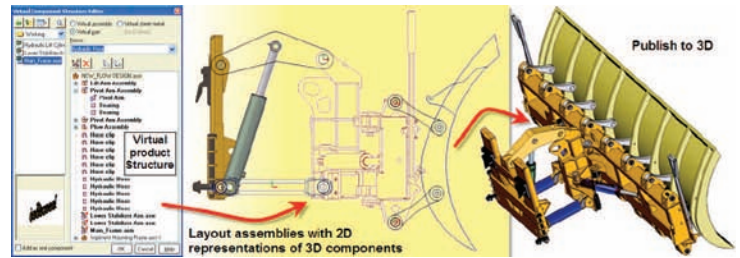

Free 2D

Solid Edge is the most complete 2D and 3D design system in its class. Whether you want to perform 2D company-wide or specific 2D design processes, you will benefit from Solid Edge 2D Drafting. Solid Edge 2D Drafting capitalizes on 10 years of production-proven capabilities developed for Solid Edge, and offers excellent drawing layout, diagramming, Goal Seeking, annotation and dimensioning controls that automatically comply with a wide range of drafting standards – including ISO, ANSI, BSI, DIN, JIS and UNI. And it is absolutely FREE to download and use.

True WYSIWYG (what you see is what you get) of imported AutoCAD DXF/DWG files, including matching color schemes, fonts, styles and backgrounds, means AutoCAD files look the same in Solid Edge as they did in AutoCAD. The AutoCAD Import wizard provides enhanced preview capabilities (pan, zoom, window area) to help users fine tune and predict translation results. Solid Edge 2D is so complete there is no reason for companies serious about transitioning to 3D to rely on Autodesk products. All 2D translation capabilities are available with full Solid Edge or Free 2D drafting.

Supporting this practical workflow, highly efficient hybrid 2D/3D design capabilities make Solid Edge unique in its ability to capitalize on a mix of existing and new data – in both 2D and 3D formats – to keep projects moving at a swift pace and allow key design decisions to be made earlier in the process. With Solid Edge, you choose the right tool for the right job at the right time, while continuing to keep all geometry in sync. Add the unique capabilities of Zero D, with its ability to establish product structure before committing to any geometry, and Solid Edge leads the industry with a simple 4-step workflow from structure to 2D layout to 3D model.

For more information, ask to see Siemens PLM Software's white paper on Hybrid 2D/3D.

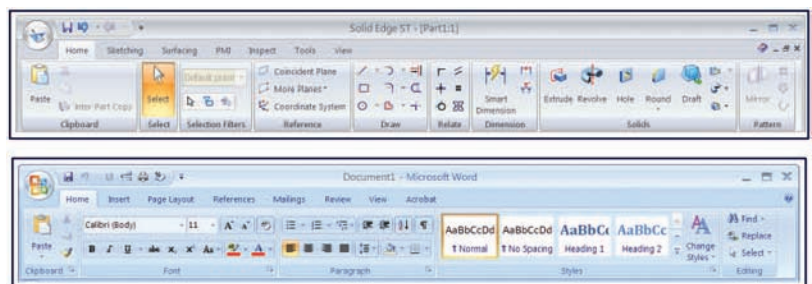

▶ 10 reasons to select Solid Edge with Synchronous Technology

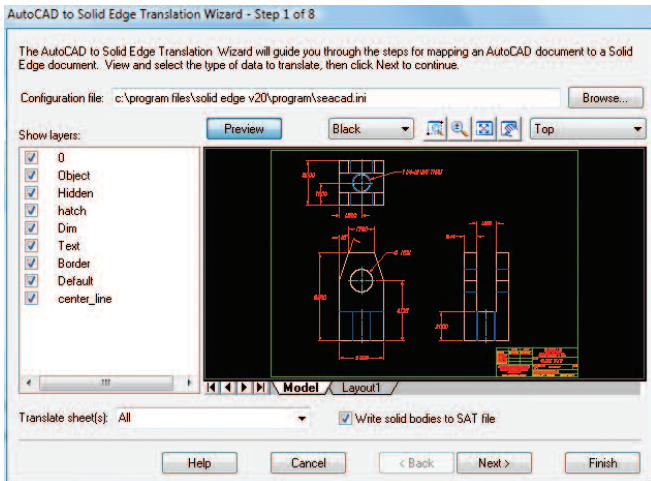

Solid Edge business advantage #2

Practical evolution from 2D:

- Solid Edge's 4-step evolve to 3D process lets you move from 2D to 3D at a pace that makes sense for your business, without losing the investment you have made in 2D data
- By leveraging existing 2D data to create 3D components for new design projects, you continue to gain from your original investment while learning the same tools that will increase your 3D productivity
- AutoCAD import wizards enable 2D data to look the same in Solid Edge as it did in AutoCAD, so your users are instantly familiar with the drawings and don't need to go through a steep learning curve
- Easy access to DWG and other 2D files means you can work with clients using Autodesk products without having to maintain separate CAD systems
- Hybrid 2D/3D design capabilities let you use the right mix of 2D layout and 3D design tools, to keep projects moving and shorten design cycles
- Using Solid Edge to intelligently combine existing or new, 2D and 3D data, lets you create the right level of detail to generate accurate bids in less time
- Solid Edge Zero D introduces tangible productivity gains and cost savings through better coordination of design team activities; project leaders can plan ahead of time, letting design engineers to focus on their area of specialization
- Using Solid Edge as a single source for all your 2D and 3D design requirements reduces your IT costs and lowers your total cost of ownership for CAD technologies
- You can control costs by deploying free Solid Edge 2D Drafting company-wide or complement Solid Edge with 2D specific design processes

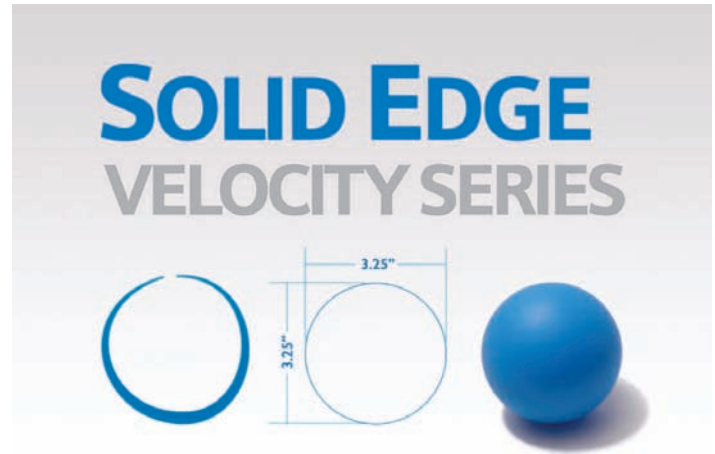

3. Complete product modeling toolset

Solid Edge boosts design productivity with specialized commands and environments to help you design much more quickly than with general-purpose CAD modeling tools. Fully tailored environments use standard terminologies and streamlined modeling commands to accelerate the design of plastic parts, frames, weldments, sheet metal, tubing, piping and wiring, plus rendered images. Process-specific features provide step-by-step guided workflows for creating individual features that are common to specific industries.

A case in point is Solid Edge's exceptional sheet metal design capabilities. Process specific features and workflows provide users with a competitive advantage by significantly enhancing productivity from sheet metal component design through documentation and manufacture.

Solid Edge streamlines drawing creation with the industry's most productive drafting system. Formed and flattened components can be detailed and dimensioned and remain associative so they automatically update when you change your design. Innovative tools for shaded views, exploded assemblies, detail and section views, hole tables and coordinate dimensioning all ensure that you represent your parts in the best possible way for customers and manufacturing.

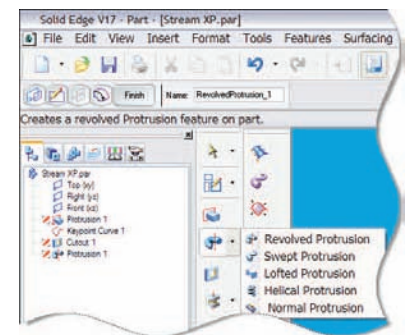

Model validation is another area where Solid Edge is unmatched. Solid Edge Sheet Metal ensures parts can be manufactured. Manufacturing support is an area where Solid Edge Sheet Metal excels. Its save flat as DXF and flat pattern generation commands allow the user to create a CAM-ready flat pattern DXF file directly from the sheet metal model without the need to create a drawing first.

► 10 reasons to select Solid Edge with Synchronous Technology

For more information, ask to see Siemens PLM Software's Sheet Metal white paper.

Other process-specific workflows are provided for:

- Frame design, for the development of rigid frame structures
- Weldments, for accelerating the design and documentation of weldments
- Piping and tubing, for a comprehensive set of design tools help designers quickly route and model piping and tubing in Solid Edge assemblies
- Engineering Reference, for integrating calculation-driven design tools that remove the guesswork from part design and eliminate the need for detailed analysis, providing a 'right the first time' design method
- Wire harness design, for integrating popular electrical wiring design packages and Solid Edge, as well as for a full suite of tools for wire and harness creation
- Standard parts, for providing a powerful parts management system that allows designers to define, store, select and position commonly used parts
- Fastener Systems, for grouping relevant hardware such as nuts, bolts and washers with mechanical fasteners like bolts, screws, rivets etc. and creating correct clearance or threaded holes in adjacent components being fastened on placement
- Photorealistic and artistic rendering, for a full range of rendering options for concept reviews right through to promotional materials
- Mold design, for establishing a powerful automated workflow that makes it fast and easy to design plastic injection molds

Common throughout each of these environments is the uniquely ergonomic Stream XP user interface, making Solid Edge easy to learn and use, and delivering a rapid return on your investment.

Solid Edge business advantage #3

Process-specific applications:

- Design better products by focusing on the engineering aspects of your projects while Solid Edge takes care of your process specific details such as wire properties or sheet metal bend radius
- Enjoy a faster return on your technology investment through Stream XP – a highly productive user interface that enables both casual and full-time users to achieve more in less time
- Reduce ECOs and costly rework by using process specific applications to manage critical design details for specific processes
- Reduce training costs through step-by-step instructions and wizards that guide you through streamlined design processes
- Build better products and reduce design time by capturing and monitoring key design parameters, such as maximum wire bundle size or manufacturability of sheet metal components

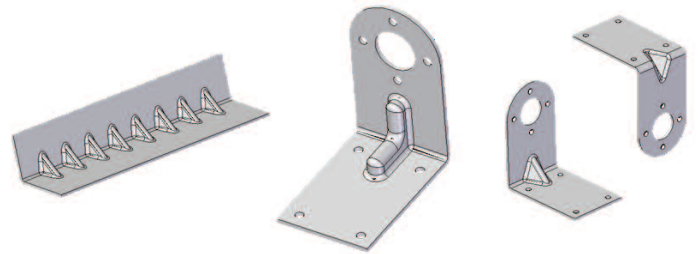

Bend information for sheetmetal part				
Sequence	Feature	Radius	Angle	Direction
1	Heb 1	300 mm	150.00 deg	Down
2	Flange 1	300 mm	90.00 deg	Down
3	Flange 2	300 mm	73.50 deg	Up
4	Flange 3	300 mm	90.00 deg	Down
5	Flange 4	300 mm	90.00 deg	Up
6	Mirror 1	300 mm	90.00 deg	Down
7	Mirror 1	300 mm	90.00 deg	Up
8	Heb 2	0.00 mm	100.00 deg	Down
9	Heb 3	0.00 mm	0.00 deg	Down
10	Heb 3	0.00 mm	0.00 deg	Down
11	Heb 3	0.00 mm	0.00 deg	Down

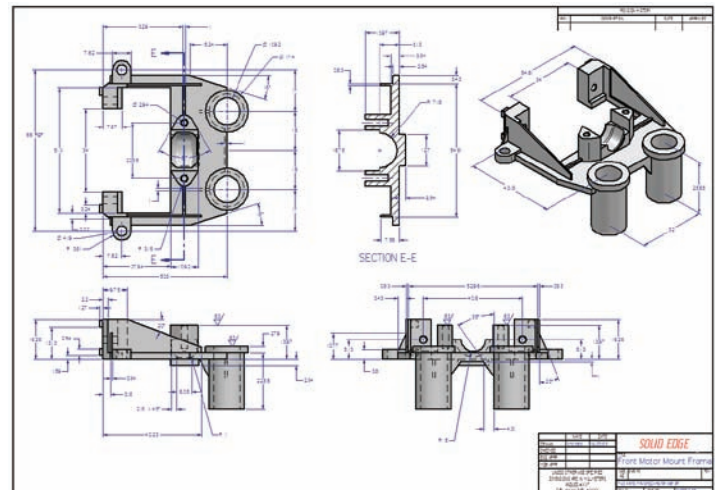
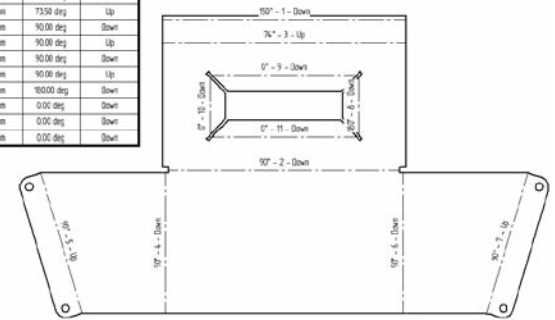

- Remove duplication waste and errors through automated manufacturing information, such as sheet metal flat patterns and reporting of tube or wire cut lengths
- Optimize resources by standardizing and reusing common components, such as fasteners and pipe fittings

► 10 reasons to select Solid Edge with Synchronous Technology

4. Best sheet metal modeling in its class.

A core design capability of Solid Edge software, the Sheet Metal environment provides an entire design-through-fabrication workflow, using streamlined modeling commands that are tailored to the unique needs of sheet metal design. Dedicated process-specific sheet metal design tools provide for efficient design of electrical cabinets, guards, HVAC and more.

If you design sheet metal parts, you face some unique challenges. Although parts are typically designed in their “formed” state, they begin as a flat sheet so manufacturability becomes a critical aspect of every feature making up the finished part. Add to this the need to account for material thickness, along with bend and corner relief, miters and deformation features and it becomes obvious that you need a highly specialized set of tools if real productivity and quality gains are to be realized.

Unmatched sheet metal design productivity

Solid Edge’s specialized sheet metal design aids deliver significant productivity gains compared to general-purpose CAD tools. Process-specific commands and structured workflows speed the modeling of sheet metal parts. Built-in intelligence saves additional time by automatically calculating material treatments and validating parts for manufacturability, while manufacturing-ready flat patterns help to eliminate scrap and rework. The result is faster time to manufacturing, backed by improved quality of the sheet metal components.

Built-in support for the sheet metal process

Solid Edge’s specialized process-specific commands streamline the design of sheet metal components by using familiar terminology and a process that requires significantly fewer steps.

You enter part properties – material, thickness, bend relief and bend equations etc. – in one place and your sheet metal parts automatically adhere to these predefined material specifications without having to define new properties each time you add a new feature.

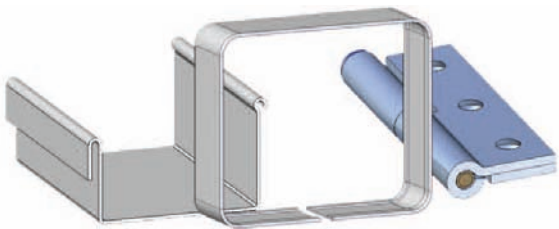

Intelligent sheet metal features

Solid Edge Sheet Metal understands the unique challenges of working with sheet metal parts. When cutouts or holes lie across a bend, a traditional cutout command would result in non-perpendicular faces.

By contrast, Solid Edge’s normal cutout command creates accurate perpendicular faces, reflecting the fact that the feature would likely be manufactured while flat, then folded.

Ensuring manufacturability

Model validation is another area where Solid Edge sheet metal is unmatched. A classic manufacturing issue involves cutouts or flanges placed too close in proximity to other cutouts or bends. Typically there is a minimum distance between bends that must be maintained to accommodate the bend die. Designers are aware of this but often don’t measure each bend for validation. Solid Edge includes design sensors that handle this operation automatically.

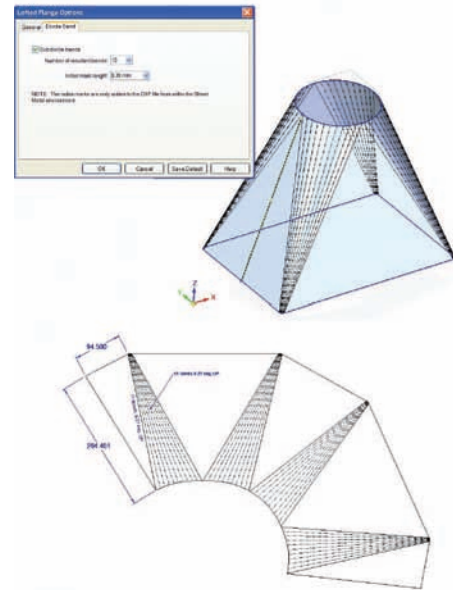

Manufacturing support

Manufacturing support is an area where Solid Edge Sheet Metal excels. Its save flat as DXF and flat pattern generation commands allow the user to create a CAM-ready flat pattern DXF file directly from the sheet metal model without the need to create a drawing first.

There is a thin line between sheet metal design and manufacturing responsibilities, more so than most design disciplines. Where the designer leaves off and the production engineer takes over is often dictated by the size of the company. Many times it is the design engineer who has to decide how components need to be made. Siemens recognizes this scenario and provides manufacturing support that can be completed at the design or manufacturing stages.

Highly productive drafting

Solid Edge streamlines drawing creation with the industry’s most productive drafting system. Formed and flattened components can be detailed and dimensioned and remain associative so they automatically update when you change your design. Innovative tools for shaded views, exploded assemblies, detail and section views, hole tables and coordinate dimensioning all ensure that you represent your parts in the best possible way for customers and manufacturing.

5. Optimal performance and management of massive assemblies

Solid Edge customers are creating assemblies well in excess of 100,000 parts. Optimal performance is essential to be able to work interactively with assemblies of this magnitude. Solid Edge has a long tradition of leadership in this area with many unique capabilities to make it practical to work with large data sets. Other companies market the ability to open and display large assemblies, but that is a very small part of the designer's workflow. Of greater importance is the ability to navigate, manipulate and document assemblies efficiently and effectively.

Solid Edge was the first to introduce the concept of simplified assemblies. Storing and opening assemblies with any combination of "simplified" or "detailed" parts ensures maximum performance, without limiting user interaction. Innovative selection and display options allow you to navigate the entire assembly tree structure without the overhead of the entire assembly, eliminating clutter and quickly isolating components necessary for each design task. And when drawings need to be generated, the combination of simplified assemblies and draft quality views ensure that you can quickly place detail views.

For some time now, advanced assembly design capabilities in Solid Edge have been used by many companies such as VAI, Anglo Platinum and Krones to lay out their factory floors and design equipment for their plants. Solid Edge, a leader in massive assembly design, now takes the next step to making it even easier to lay out and document factory floors. With new capabilities to open and work with actual machine geometry in the context of large assemblies and their associated drawings, Solid Edge further addresses the needs of the heavy industrial vehicles, large mechanical machinery, process plant equipment and power industries.

Solid Edge is the first mid-range modeler to take advantage of zones. Zones make working with massive assemblies even more manageable and boost performance, allowing designers to define a permanent range box to



isolate areas of large designs they are responsible for at a subsystem level. Intelligent caching allows retrieval of only the parts in the zone, without having to open component files to determine if they lie in the zone or not. This creates a significant performance boost when switching zones or opening a massive assembly.

To help designers lay out factory floors and/or machine designs, manual component positioning capability allows existing subassemblies to be quickly copied, moved, rotated or arrayed within an assembly. To remove any restrictions, assembly relationships to existing components are ignored, while those integral to the subassembly remain intact. Subassemblies can be simply dragged to a new location or precisely moved using coordinates, vectors or exiting components.

Systems Design is a unique Solid Edge approach to building intelligent assemblies. Where traditional assembly design focuses primarily on how parts fit together, Systems Design places additional emphasis on function, allowing you to create intelligent digital prototypes that emulate the real-world situations for which they are being designed. Motion simulation tools in Solid Edge let you create fast, accurate and realistic conceptual motion studies during the design phase, quickly and easily defining motion relationships and drivers, such as: gears, pulleys, hydraulic cylinders and motors.

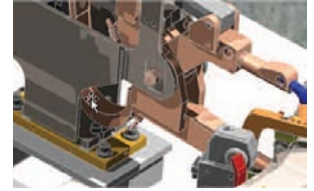

If you regularly work with massive assemblies and/or their associated drawings, the 64-bit edition of Solid Edge gives you the extra horsepower you may need.

For more information, ask to see Siemens PLM Software's white paper on Large Assembly Performance.

Solid Edge business advantage #5

Optimal performance and management of massive assemblies:

- Solid Edge's capability to create a complete digital mockup of your designs means you find problems early in the cycle, helping you avoid ECOs and costly rework
- Focused tools for assembly manipulation and visualization let you focus on the design task at hand, rather than battling software performance
- You can extend Solid Edge large assembly design capabilities into plant equipment design and layout on factory floors
- Systems Design capabilities allow part and assembly intelligence to be captured and stored as a single unit, saving time and money by optimizing and reusing parts, processes and materials
- Powerful production ready drawing tools mean you can rapidly create 2D drawings of even the largest assemblies in record time
- Sensors monitor critical design variables, keeping projects on time and on budget by checking for manufacturability, build errors, cost increases and more
- Dynamic "on-the-fly" creation and configuration of assembly families saves significant design time by quickly configuring new or custom design and product lines
- System libraries promote commonality and optimize resources by easily finding and reusing common components, sub-assemblies and mounting details



► 10 reasons to select Solid Edge with Synchronous Technology

6. Production-proven 2D drafting

Solid Edge leads the market in drawing creation productivity with a focus on the four key components that affect the time required to progress from design to print, namely layout, performance, annotation and revision. With Solid Edge, you simply select the 3D model, and standard views are automatically created. Additional views such as sections or details are added with a simple click. Exploded views, balloons, parts lists and BOMs are easily created and updated as changes are made to your 3D models. Quicksheet templates eliminate repetitive tasks by predefining a drawing template that automatically defines the layout for new drawings, including all standard sections and detail views, as well as parts lists and balloons. Innovative management tools make it practical to develop detail drawings from your largest assemblies, while practical and intelligent dimensioning and annotation tools means you can create fully dimensioned views in seconds.

As your designs evolve and change, so too must any associated documentation. Unique Solid Edge tools persistently monitor your 3D model and automatically highlight and tag views and dimensions that are no longer current relative to the model. By understanding why your drawings are out of date, and having Solid Edge tell you what needs to be done to update the drawing, you can make faster and more accurate revisions, without the need for detailed and lengthy manual checks.

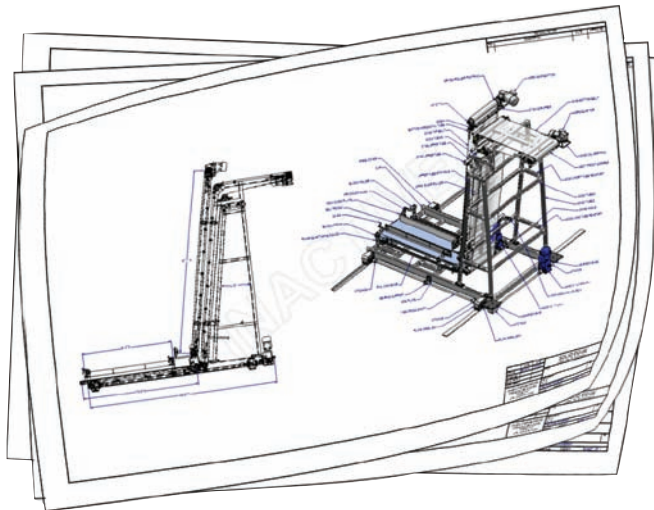

Solid Edge's complete 2D drawing tools are augmented with a new 'drawing review mode' that allows rapid opening of a drawing for reviewing, adding dimensions, measuring or printing regardless of how big or detailed your drawing. Solid Edge Draft's unique architecture allows instant opening drawings of massive assemblies that drastically decrease drawing access time from minutes to seconds. Inactive drawings, as they are referred to, allow you to add dimensions and annotations, and extract part numbers. Inactive Drawings are ideal for drawing reviews, quick print jobs for the shop floor, continued detailing by teams with or without 3D data being present.

Solid Edge Goal Seeking takes graphical engineering problem solving to a new level and avoids labor intensive iterative calculations by allowing design engineers to

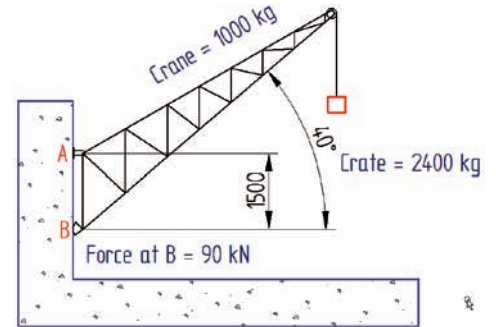

perform two-dimensional what-if engineering calculations, with a combination of 2D parametric geometry, mathematical formulas, variables and part properties. Knowing the target value of an engineering calculation, Goal Seeking allows users to set certain parameters, while the system varies other factors to achieve the desired result. Goal Seeking concepts, familiar to many, in Excel spreadsheets have now been applied to engineering and design by allowing engineers to solve problems that are best expressed graphically. Results can be used to drive 3D geometry in a true hybrid 2D/3D design environment.

Solid Edge business advantage #6

Production-proven 2D drafting:

- Start in 2D or finish in 2D; Solid Edge's drafting environment enables you to be more agile, giving you flexibility to edit and maintain existing 2D drawings, create new 2D layouts or develop drawings from 3D models
- Provide accurate manufacturing information using Solid Edge's full suite of dimensioning and annotation capabilities that adhere to international standards
- Deliver more accurate bids in less time through the ability to quickly create fully detailed drawings from multiple configurations of your products
- Take advantage of Solid Edge's free 2D/3D view and markup tools to open up design data to your extended organization; collaborate with your customers and suppliers, and find errors early while costs are low
- Avoid costly rework through Solid Edge's ability to track and maintain associativity between the 3D model and its many different drawings; drawing views give immediate feedback that designs have changed, while revision and version controls mean that data is always accurate and up-to-date
- Speed time-to-bid and time-to-market through automated bill of materials and parts lists that are accessible by purchasing and other departments
- Customize Solid Edge's standard drawing and quicksheet templates to meet your company or customer standards and ensure all documentation automatically adheres to design standards, processes, materials and templates

7. Scalable design and failure analysis

As development cycles shrink to meet market demands, it is becoming less feasible to build and test physical prototypes. Companies need proven simulation tools to help improve product performance and reliability, while reducing recalls that may result from limited product testing. The right simulation tools can save many thousands of dollars and help you get to market faster with a product that you know is a winner because of your ability to perform trade-off studies, evaluate different designs and optimize the design in such areas as reduced weight or stronger-but-cheaper materials.

Siemens PLM Software owns and develops Femap® software – the world's leading advanced engineering analysis environment. Written by engineers for engineers, Femap is widely used by the world's leading engineering organizations, with more than 20,000 direct customers, of all sizes, in all industries. Femap's powerful in-depth functionality solves challenging engineering problems quickly and easily.

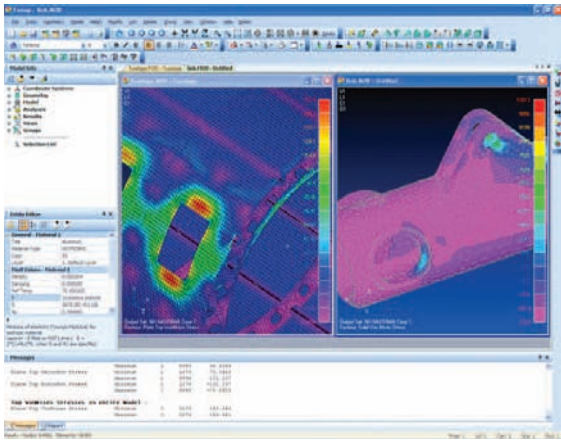

Solid Edge is able to take advantage of Siemens' unique position with Femap to offer two complementary methods for design analysis and validation. Both solutions also utilize well-proven Nastran solver technology for accurate and repeatable results.

Created specifically for design engineers, Femap Express provides preconfigured, best practice, process guidance to the user for fast, accurate finite element analysis (FEA). Using the same process based approach found in other Solid Edge capabilities, finite element technology is presented to the user in an easy-to-follow workflow and detailed analysis tasks are undertaken within a single Solid Edge window.

For more detailed and advanced analysis, Solid Edge models can be associatively passed to Femap. Femap from Siemens is the world's leading window's-based engineering simulation tool for FEA. Engineers worldwide use Femap to model and simulate everything from simple solid components to entire spacecraft assemblies throughout a broad range of engineering disciplines. From simple linear static analysis right through to advanced solutions-based computational fluid dynamics, engineers and analysts use Femap to virtually simulate a complete

range of product behavior before committing to expensive product development plans.

Solid Edge business advantage #7

Scalable design and failure analysis:

- Femap and Femap Express perform fast accurate analysis, and validate that parts are 'fit for purpose' without building physical prototypes
- By moving analysis to an earlier stage in the design cycle, you ensure designs will function as intended and avoid ECOs, costly rework and recalls
- You can avoid process duplication and waste by eliminating the need to build separate, meshed geometric models in order to run FEA analyses
- You can lower development costs by aligning CAD design and FEA technology and working together within a common user interface that enables design engineers to quickly assess whether designs will meet specifications
- You can enjoy peace of mind by knowing that you are using proven technologies that are scalable to meet your growing business requirements; Femap is widely recognized as the world's leading Windows-based engineering simulation tool for finite element analysis. The Nastran-based solver is well recognized and respected throughout the industry
- You can optimize resources by working from the same data; When you need to run complex, high-end analyses, your analysts can use Femap to test the same up-to-date design and collaborate with the design team to ensure necessary changes are incorporated

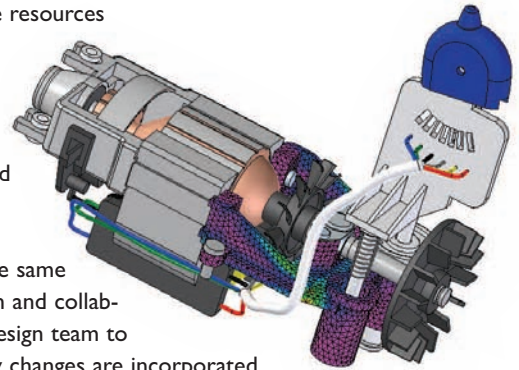

8. Collaboration throughout the supply chain

Global companies require efficient tools for exchanging design data, even when their partners are using disparate design tools. With over 4 million users worldwide, JT is proven technology and widely accepted as the standard for collaboration, allowing anyone in your supply chain to share intelligent 3D data regardless of the CAD system used to create the file. JT files contain all the important design data needed to collaborate in today's engineering world. Different combinations of geometry information, assembly structure and attributes allow OEMs and suppliers to share a level of "intelligence" with a level of security that is appropriate to each shared project.

With enhanced 3D annotation tools in Solid Edge, product manufacturing information (PMI) is easily stored with 3D models and assemblies. These "smart" models reduce the need for drawings in

► 10 reasons to select Solid Edge with Synchronous Technology

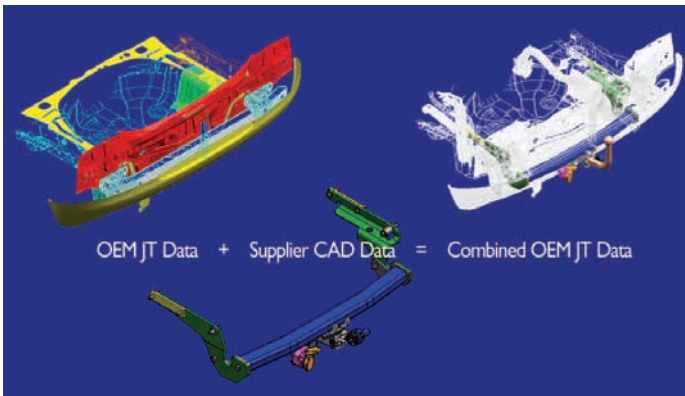

design reviews and can be used for many downstream purposes, including manufacturing. The inclusion of 3D product definition in a single digital file improves productivity, ensures the 3D information is accurate and in sync and removes the need to keep multiple documents up to date.

Fully supporting both JT and PMI data, XpresReview is an electronic design review solution that allows you to easily share multiple documents in a collaborative environment. Used independently or in conjunction with Solid Edge or NX™ software, XpresReview easily combines 3D models and other associated documents into a single package collaboration file (PCF), so participants in your review process have all the information they need to communicate effectively. Recipients of the package can use XpresReview to quickly and easily interrogate its contents – viewing, measuring and marking up the data.

Solid Edge business advantage #8

Collaboration throughout the supply chain:

- Communicating with customers and suppliers using easy-to-visualize, accurate and up-to-date information reduces misinterpretation as designs pass through supply chain
- Solid Edge's collaboration tools allow shortened and more decisive design reviews and help cross department and cross functional teams make faster decisions to meet shrinking delivery cycles and customer expectations
- Different combinations of geometry information, assembly structure and attributes allow OEMs and suppliers to share a level of "intelligence" with a level of security that is appropriate to their shared projects
- By quickly evaluating design options early in the design phase, changes can be incorporated or errors spotted while costs are low
- PMI data within 3D model delivers a digital representation of a product, so critical information is always accurate and up to date, reducing ECOs and costly rework
- Design teams and their activities are better coordinated reducing wasteful stages in the review process
- PMI rich "smart" models reduce the need for drawings in design reviews and can be used for many downstream purposes, supporting lean initiatives and manufacturing

- PMI information in Solid Edge is in compliance with world standards, supporting initiatives with global partners
- PMI can be viewed by shop floor assembly workers or maintenance engineers to reduce assembly time and serve as training aids, as well as delivering better maintenance and support documentation with products
- 3D Dimensions created in PMI views, can save time creating 2D drawings – they can be extracted as and when 2D drawings are required

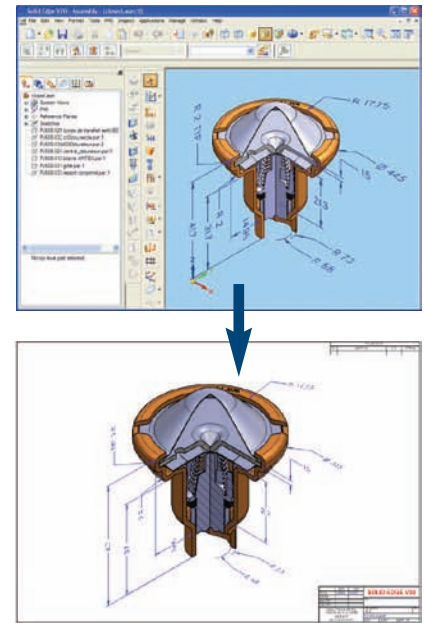

9. Scalable design and design management solutions

Unique in the PLM industry – scalability and interoperability with all products in our portfolio is a core vision of Siemens PLM Software. Siemens has a clear and consistent development strategy, allowing different products to co-exist, offering a safe, scalable approach for both design and data management. If you are already using products from our portfolio, Siemens is committed to providing functionality that allows Solid Edge to coexist within your organization. Solid Edge is completely scalable and extensible to both NX and the Teamcenter® software portfolios when your business requirements change. Siemens' associative embedding technology is already production proven with many customers using combinations of NX and Solid Edge. Each product contains exclusive technology to allow part, assembly



and attribute information to be passed between them. Solid Edge parts can be used in NX assemblies, with designers having the ability to update any of the parts from the assembly level

in NX. Associative embedding ensures that updates to the original files will be recognized and acted upon in either system, keeping collaborative projects in sync at all times. With Solid Edge and NX, Siemens offers the industry's only full CAD spectrum, ensuring the success of your technology investment.

► 10 reasons to select Solid Edge with Synchronous Technology

With its groundbreaking Insight technology, Solid Edge became the only mainstream mechanical system to merge design management capabilities with the CAD tools that designers use every day. Building on the success of Insight, Siemens now lets you choose from a range of easily scalable cPDM solutions, setting a new standard in CAD/PDM integration with Solid Edge. Solid Edge Insight continues to provide



proven management capabilities for departmental teams. Solid Edge's integration with the powerful Teamcenter platform provides seamless and transparent connectivity between the

applications. All essential Solid Edge commands are encapsulated, making sophisticated data management functions easily available. Solid Edge-related data is easily captured for re-use in future projects without placing an additional burden on the designer; while full scalability means you can grow your cPDM solution to meet growing business demands without starting from scratch.

Solid Edge business advantage #9

Solid Edge is the first CAD application to support Teamcenter service oriented architecture (SOA) providing robustness, performance and support for the new Teamcenter architecture that allows access to a central database from remote sites via company wide area networks.

Scalable design and design management solutions:

- Choose the tools that are right for you today, with peace of mind that you can easily expand the scope of your software requirements to meet growing business demands
- Quickly repurpose data within a managed environment to leverage your assets
- Win more business and save costs by finding and reusing existing data and using this information to produce faster more accurate bid requests
- Use intuitive collaboration tools for design reviews with internal teams, customers and suppliers; make better decisions early in the development process, when costs are low
- Easily access up-to-date design data and related information, coordinating all business activities from design through marketing and sales

- Reduce training costs and get up to speed quickly through the use of built-in best practices and wizards that guide the user through everyday tasks and processes
- Lower your total cost of ownership through preconfigured out-of-the-box products that are easy to deploy with minimal or no dedicated IT support
- Hold shorter and more effective decisive design reviews with communication tools that help you make better and more informed decisions with your internal teams, customers and suppliers
- Take full advantage of existing resources by reusing common parts and processes already developed or deployed
- Share valuable design data internally and throughout the value chain by leverage the interoperability between Solid Edge and NX – reducing errors and removing duplication and waste
- Leverage SOA to provide remote access in lieu of multi-site implementations for individuals at remote locations to access central projects

10. Velocity Series

Solid Edge is the core design component of Velocity Series – a comprehensive family of modular, yet integrated solutions addressing the product lifecycle management (PLM) needs of the mid-market. Consisting of a preconfigured family of digital product design, analysis, NC programming and data management software offerings, Velocity Series leverages the industry's best practices to provide significant breakthroughs in ease-of-use and deployment. Mid-sized manufacturers can leverage the power of Velocity Series to transform their process of innovation while maintaining a low total cost of ownership. All Velocity Series products are completely scalable to the full range of Siemens' industry leading, enterprise-level PLM portfolio. Understanding that not all companies are the same, Velocity Series can be purchased standalone or as an integrated suite allowing you – at any time – to scale to Siemens' full complement of PLM solutions. By either purchasing one or all of the components, the portfolio offers immediate flexibility with a predefined growth path to advanced capabilities, as your business and organizational needs grow. This cost-effective solution allows mid-size manufacturers an entry point into PLM with a low total cost of ownership and dramatic return on investment. All of these characteristics can only be found from the leader in PLM, Siemens PLM Software.

- PLM for mid-sized manufacturers
- Modular, yet integrated solutions
- Preconfigured with industry best practices
- Easy to deploy and use
- Native Microsoft
- Low total cost of ownership

▶ 10 reasons to select Solid Edge with Synchronous Technology

- Scalable to the full range of Siemens' PLM solutions
- Backed by Siemens PLM Software, the leader in PLM
- Supported by Teamcenter Express to provide collaboration across multiple departments and over multiple sites, support multiple CAD systems and leverage additional workflow capabilities to manage product release and ECOs
- Extendible with Femap, a pre and post processor finite element modeling application known for its tight integration with Nastran, the most extensive and reputable CAE solver in the industry
- Extendible with NX CAM to expand design productivity and efficiency into manufacturing; NX CAM provides a dynamic link to product models for accurate and timely production tooling, molds, dies and work holding jigs and fixtures

Solid Edge business advantage #10

Velocity Series:

- Enjoy peace of mind, knowing Velocity Series is from the PLM leader – Siemens, who has amassed years of experience of delivering and implementing process oriented solutions, while capturing knowledge from a variety of world class manufacturers; Velocity Series is developed with the needs of the mid-market in mind, addressing many specific problems faced by this market sector
- Take advantage integrated products, developed on a standard Microsoft platform, to deploy technologies that address your business needs without requiring significant IT investments or staffing
- Maximize the return on your investment through built-in best practices that allow fast deployment with a minimal IT infrastructure and minimal training requirements, deliver low total cost of ownership at a competitive initial purchase cost and reasonable maintenance
- Reduce design to manufacture lead times with an integrated suite of products for designing, testing, managing and manufacturing products in a broad range of industries
- Leverage valuable design data internally and throughout your value chain, communicating with customers and suppliers to get to market faster, with products your customers will buy
- Start wherever it makes sense for your business, and know that Siemens has a full range of scalable solutions that will grow with you and protect your investment

About Siemens PLM Software

Siemens PLM Software, a business unit of the Siemens Industry Automation Division, is a leading global provider of product lifecycle management (PLM) software and services with 5.5 million licensed seats and 51,000 customers worldwide. Headquartered in Plano, Texas, Siemens PLM Software's open enterprise solutions enable a world where organizations and their partners collaborate through Global Innovation Networks to deliver world-class products and services. For more information on Siemens PLM Software products and services, visit www.siemens.com/plm.

► For more information, contact your local Solid Edge representative:

SIEMENS

Division headquarters

United States
Granite Park One
5800 Granite Parkway
Suite 600
Plano, TX 75024
972 987 3000
Fax 972 987 3398

Solid Edge – www.siemens.com/solidedge

Americas
800 807 2200
Fax 314 264 8922

Europe
44 (0) 1202 243455
Fax 44 (0) 1202 243465

Asia-Pacific
852 2230 3308
Fax 852 2230 3210